



HAUSMANN INDUSTRIES, INC.

130 Union St • Northvale NJ 07647 USA • Tel: (201) 767-0255 • Fax: (201) 767-1369 • www.hausmann.com

Installation/Operation Instructions

Series 1440 - Powermatic® Mat Platform



Step 1

Place (2) Base Assemblies (A1 and A2) parallel to each other as shown in place on the floor in the location where you want to install the mat platform.

"X" Distance between base plates varies as follows:

<u>Size of Top</u>	<u>Distance Between Plates</u>
6' x 8'	52"
5' x 7', 4' x 7'	45"
4' x 6'	39 3/8"

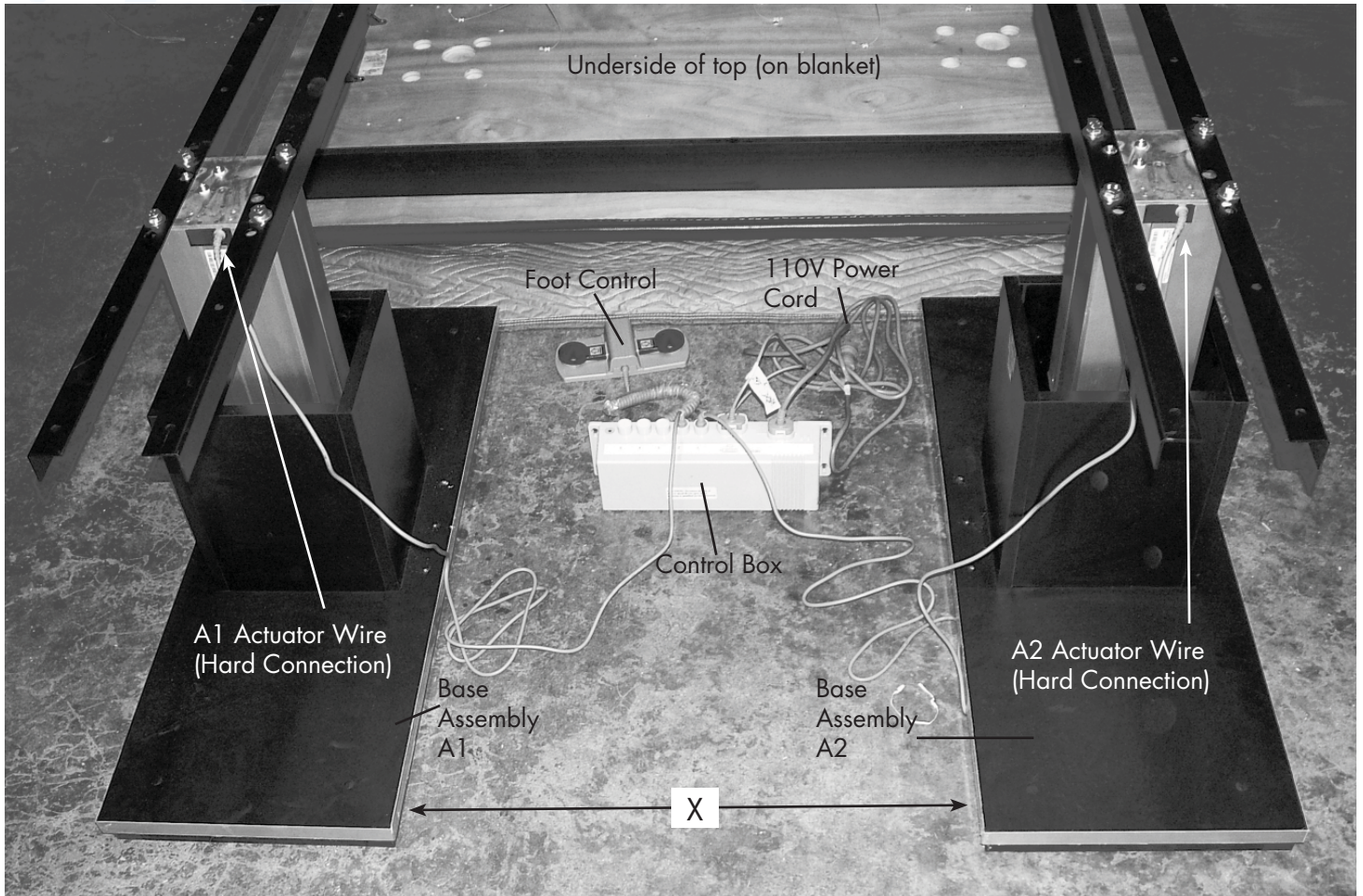

Step 2

Before doing any assembly, pre-test motors. Plug power cord into grounded wall outlet. The electrical rating for Series 1440 is 110V AC, 60Hz, 1.6 Amps. The 3-prong hospital grade grounded plug must be plugged in 3-pronged, grounded, non-isolated, correctly polarized 110V AC receptacle. **Failure to do so could result in personal injury or damage to equipment.**

- A. Step on UP button and elevate unit about 5" - 6".
- B. Step on DOWN button and lower down as far as it will go.
- C. Step on UP button and elevate up to maximum height.

NOTE: During the pre-testing, the green light on the Control Box should be on to indicate there is power to the control box. If for any reason there is no response, see the trouble shooting guide on page 8 for possible problems - most common of which is loose plug connections into control box.

You have completed initial test. Unplug power cord from power source as electrical power is not needed for remainder of assembly.

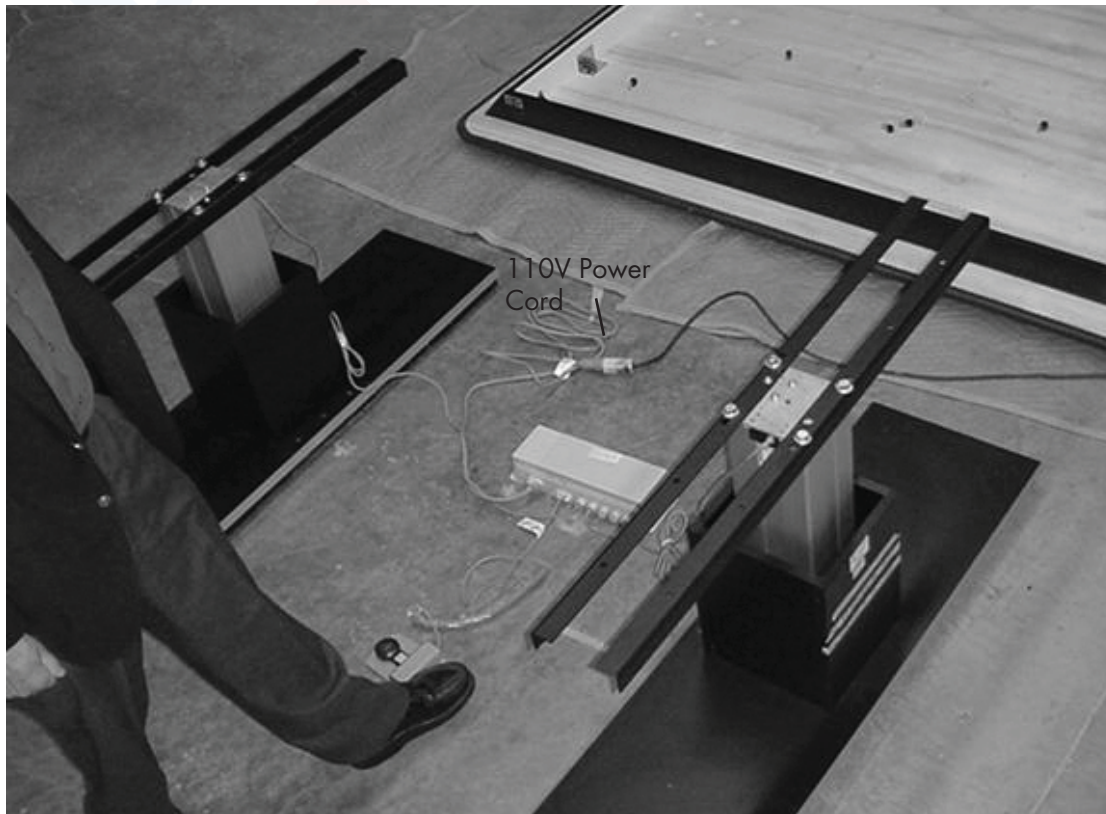

Detail of Control Box

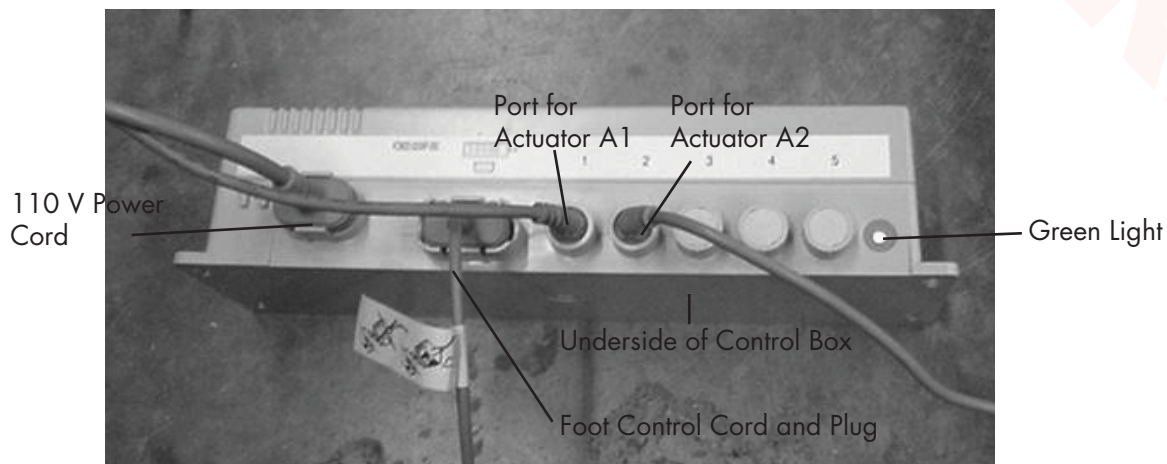

Step 3

Place upholstered top over base assembly.

Place underside of upholstered top so the exposed bolt heads on each actuator fit into (4) routed holes on each side of wood underside of top and (3) holes in black angle irons line up with the (8) pre-drilled holes in underside.

Secure each black angle iron to subtop with (4) 1/4" - 20 x 7/8" machine screws "D" into pre-threaded t-nuts in underside of top. Total of sixteen 1/4" - 20 x 7/8" machine screws needed for all (4) black angle irons.

Upholstered top placed on base assembly.

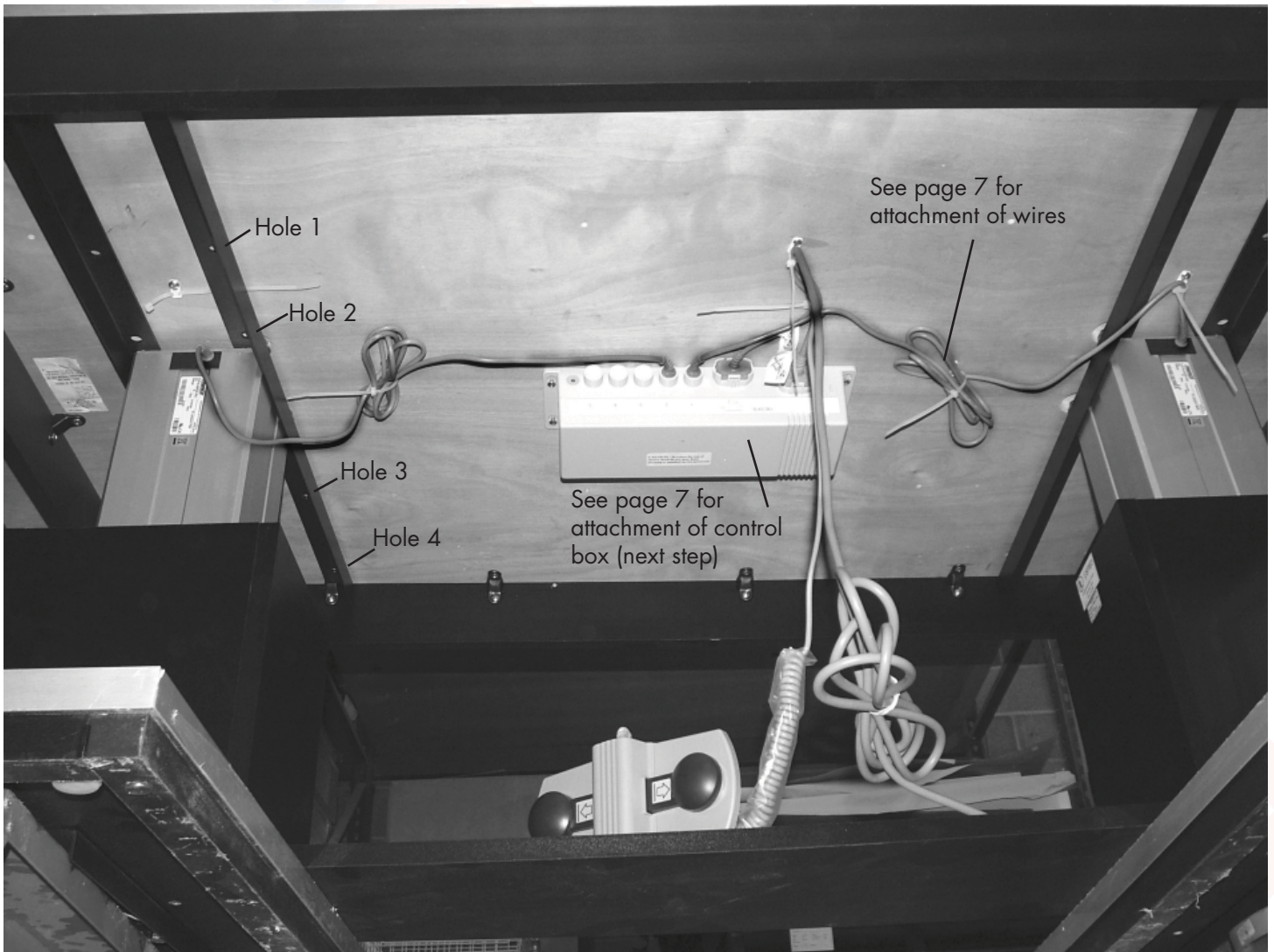

Step 4

Attach control box to underside of top with keyhole attachment. Tighten down keyhole screws with phillips head screwdriver to secure control box to underside. Secure power cord and footswitch wire together to underside of top with two cable ties as shown.

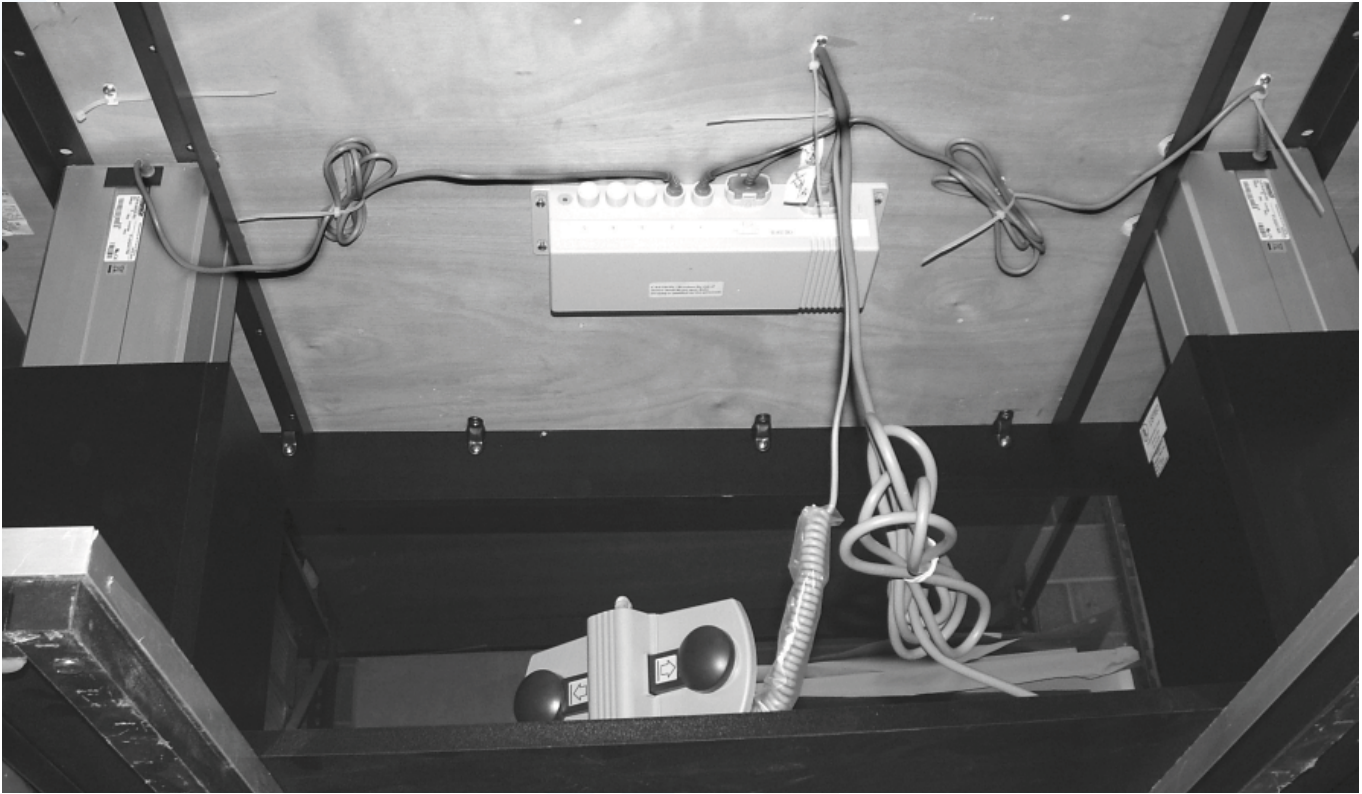

Step 5

Use cable zip ties to properly secure actuator wire to underside of top. First secure wire with cable tie closest to actuator then bundle excess wire and secure with cable tie located between base assembly and control box. Repeat procedure for Actuator A2.

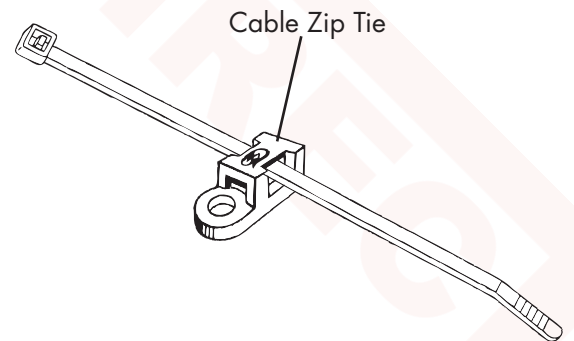
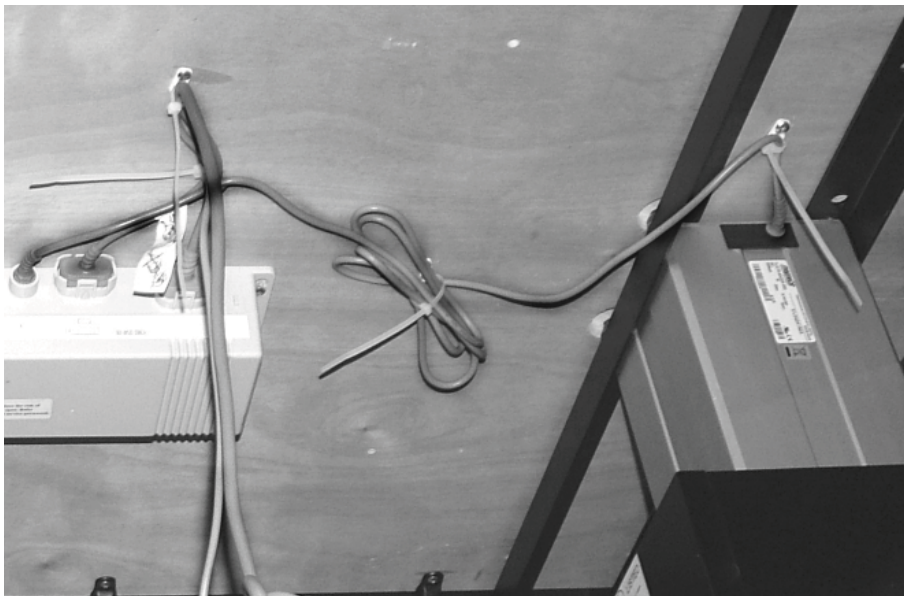

Step 5

Place Shelf "C" between A1 and A2 Base Assemblies. Both ends of shelf must rest on base plate and butt-fit to black "box" around actuator.

Secure shelf with (3) 1 3/4" x #8 flat head phillips head screws per each side (total of six screws needed). Apply pressure as holes are not pre-drilled in base plate.

Cord from Actuator A1

Cord from Actuator A2

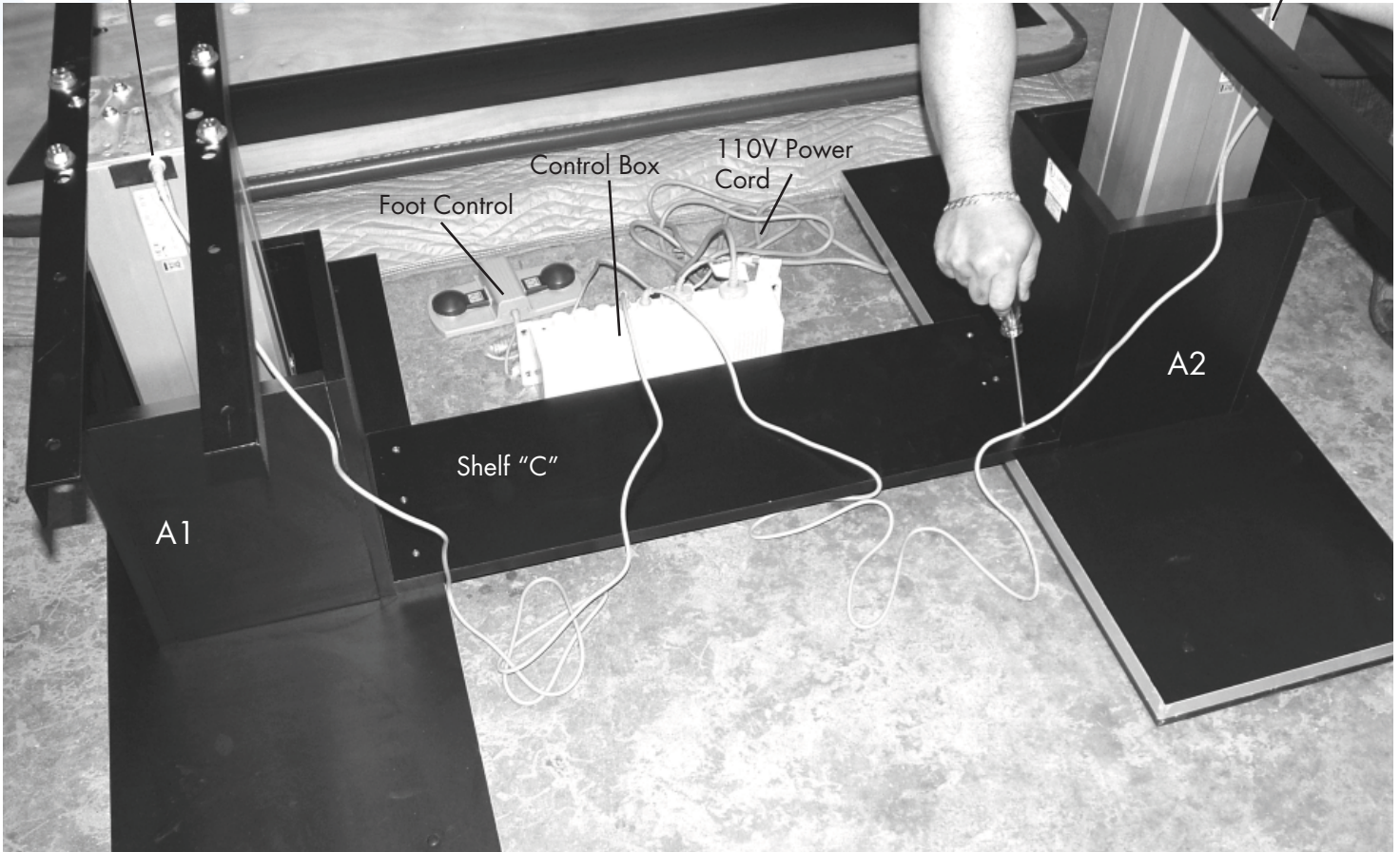

Step 6

Place level on shelf and around perimeter of base plates to check level. (Base plates must be adjusted to level to assure proper performance of unit.)

To level: Remove black plastic level caps at (4) corners and (2) adjacent to black box housing for actuator. There are a total of six* levelers per each base plate. Use slotted screwdriver and turn clockwise to elevate leg, and counter-clockwise to lower leg. Check level to be sure shelf and each base is level.

*Note: Model 1440-46 and 1440-47 only have four levelers per base plate.



Detail of Control Box Connections

in case of replacement of any components

IMPORTANT NOTE: Actuator plug must be fully inserted with top and bottom notches on plug at 12 o'clock and 6 o'clock position. After fully inserting actuator's plug, you must turn plug clockwise 1/8th of a turn to lock into position. (To unlock push in and turn plug 1/8th of a turn counterclockwise is notch of plug lines up with 12 o'clock hash mark at top of round ports.

This is most frequent problem in that plug is sometimes plugged in at 12 o'clock but not fully inserted and not turned 1/8th turn to right to lock.

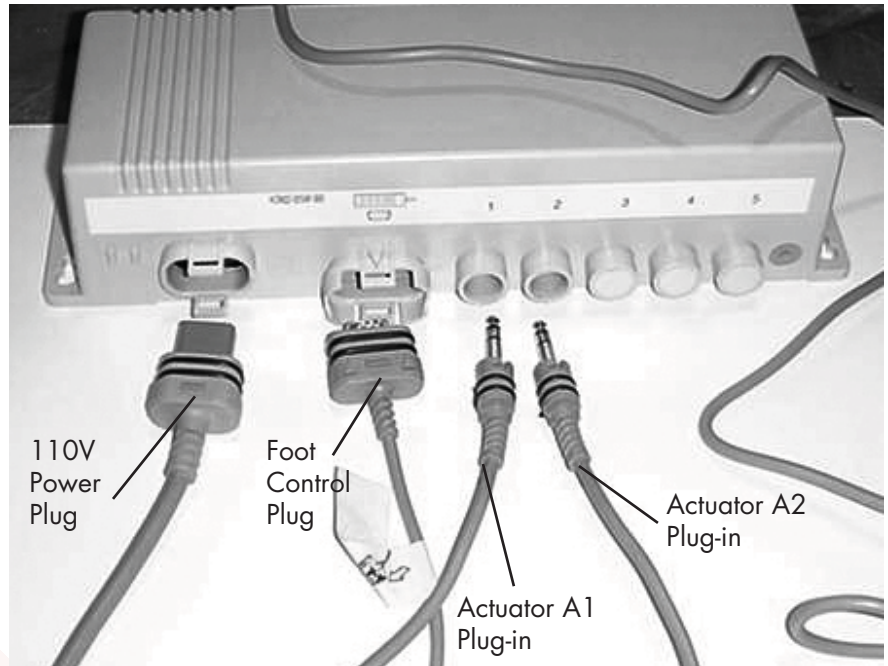

Detail of Control Box Connections with all plugs inserted into place for operation.

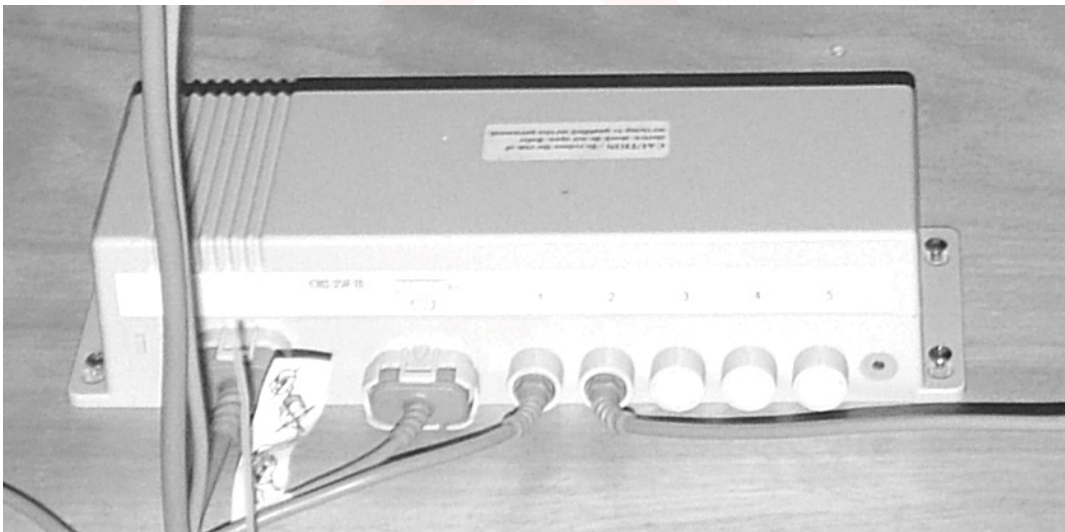







Trouble Shooting

Symptom: System not working after all connections are made and unit is plugged into wall outlet.

1. Is the green light on upper left side of control box on? If not, there is not power to control box. Verify that electrical cord is plugged into control box and plugged into wall outlet.
If unit still does not work, verify that the wall outlet is active by plugging in another appliance or lamp. Could be "shut-down" due to ground-fault de-activation or faulty outlet.
2. Verify that both left and right actuator's plugs are properly plugged into ports 1 and 2 on control box.
Actuator plug must be fully inserted, with top and bottom notches on plug at 12 o'clock and 6 o'clock positions. After fully inserting actuator's plug, you must turn plug clockwise 1/8th of a turn to lock into position.
3. When you depress foot control, you should hear a click in control box to reflect active operation of foot control. If foot control does not cause clicking sound in control box then it could be a faulty foot control. If you have a second unit of current design that is working, then swap "good" foot control for "bad" one to see if that corrects the problem. If you get a clicking sound then foot control is probably active (foot control triggers relay in box).
4. If green light is on in control box and foot switch is operational and there is no clicking sound when foot control is depressed it could be a faulty relay in control box, hence replace control box.
5. Check all wires and connections to make sure wires are not cut and all connections are in firmly and operative.

Table of Symbols

No.	Symbol	IEC Publication	Description
1		417-5032	Alternating Current
2		417-5031	Direct Current
3		348	Attention, consult ACCOMPANYING DOCUMENTS
4		417-5333 878-02-05	Type BF Applied Part
5		N/A	Dispose of properly
6		N/A	Table movement, UP
7		N/A	Table movement, DOWN

Electrical Specifications:

Input: 120 VAC / 1ph / 60 Hz / 2.5 Amps Max
Output: 24 VDC / 6 Amps

Environmental Conditions - Normal Operations:

Ambient Temperature: +10 to +40°C (+50 to +104°F)
Air Humidity: Max. 85%

Environment Conditions - Storage / Transportation:

Ambient Temperature: -20 to +60°C (-4 to +140°F)
Air Humidity: Max. 95%

Recommended Cleaning Solution and Procedure:

UNPLUG UNIT BEFORE ATTEMPTING ANY CLEANING AND/OR DISINFECTING.

Infective material should be removed by scrubbing with an approved germicidal solution. After scrubbing, rinse with a wet cloth and allow to dry.



Please join Hausmann's effort to reduce paper use and keep the planet green by using our paperless Warranty Registration form. Visit www.hausmann.com and click on Warranty Registration. If you do not have web access or prefer the form be mailed or faxed to you, please call Hausmann Customer Service.

As of January 1, 2010, we will no longer include the paper based forms, please visit the online link to fill in your Warranty Form.



HAUSMANN INDUSTRIES, INC.

130 Union St • Northvale NJ 07647 USA • Tel: (201) 767-0255 • Fax: (201) 767-1369 • www.hausmann.com

Model 1440 - Special Wrench Instructions

ATTACHING POWER PLUG AND FOOT SWITCH PLUG TO CONTROL BOX

When attaching Power Plug and Foot Switch Plugs to Control Box ensure that the plugs are inserted in the correct position to prevent damage to the control unit and /or the plug. (Note plug shape.)

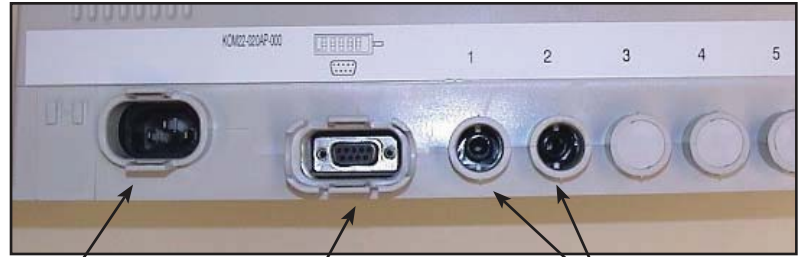

Power Plug Port Foot Switch Port Actuator Port

DETACHING POWER PLUG AND FOOT SWITCH PLUG FROM CONTROL BOX

The two lines may only be detached from the control box by means of special plastic wrench with which the brackets can be separated, by pulling the plug (see illustrations). The brackets can break if they are opened too wide. Strain relief and watertightness are no longer guaranteed. Note: Some force is still required to remove plug from Control Box.

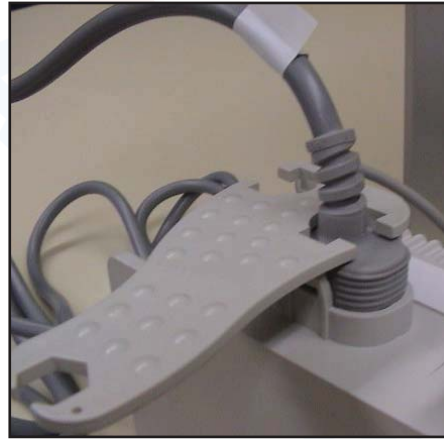
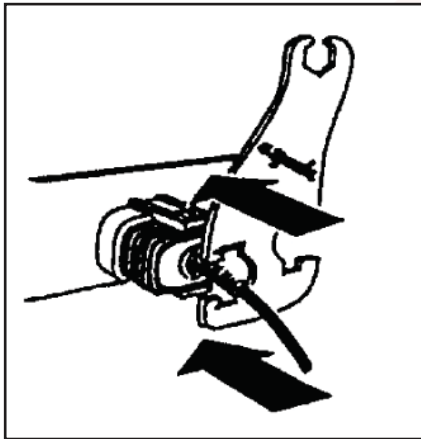

ATTACHING AND DETACHING ACTUATOR PLUGS TO CONTROL BOX

The 1/4" plugs must be inserted into the control unit until the O-rings are no longer visible, and turned approx 30° to the right as far as the stop by means of special plastic wrench to lock. If this is not done, strain relief and water tightness are not guaranteed.

